

MP KOVANIA®

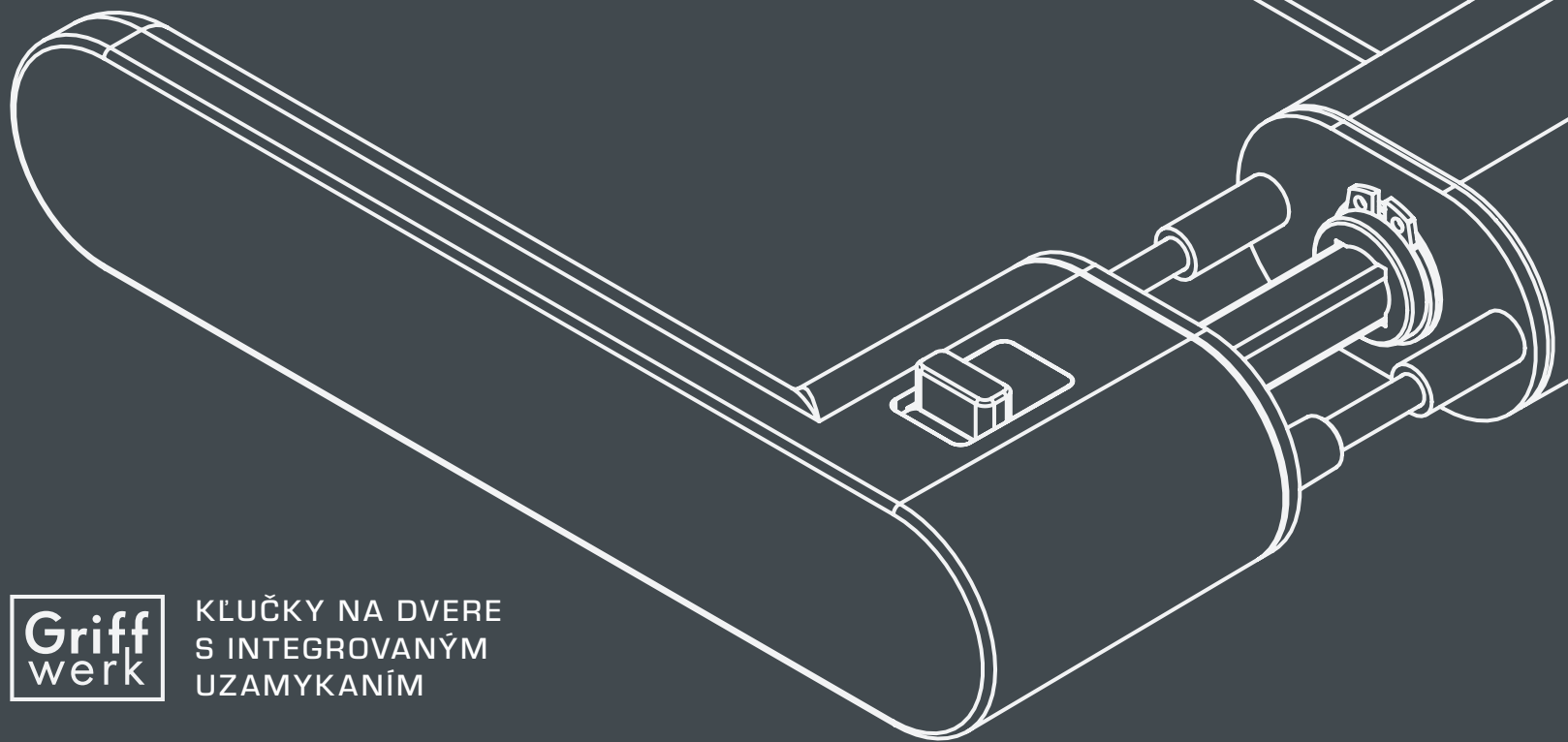

**Griff
werk**

KLUČKY NA DVERE
S INTEGROVANÝM
UZAMYKANÍM

MP KOVANIA[®]

KOVANIA NA DVERE, STAVBY A NÁBYTOK



Vstúpte do sveta MP KOVANIA, ktorý ponúka nekonečný výber kľučiek, kovaní a doplnkov

Pod slovenskou značkou MP KOVANIA pôsobíme už viac ako 22 rokov v oblasti dverných kovaní a doplnkov na celom území Slovenskej republiky a od roku 2008 aj na území Českej republiky. Prevádzkujeme veľkoobchodný a maloobchodný predaj so sieťou maloobchodných partnerov. V našom segmente si dlhodobo budujeme meno kvalitného a spoľahlivého partnera. Dbáme najmä na stabilitu, spoľahlivosť v poskytovaní produktov a služieb, ako aj na kvalitnú a ochotnú predajnú i popredajnú starostlivosť.

V tomto katalógu vám prinášame výnimočné kľučky značky Griffwerk, ktoré spájajú nadčasový dizajn s prvotriednou kvalitou. Griffwerk GmbH, založená v roku 1999 v Nemecku, vyrába kľučky z nerezovej ocele a zamaku, čo garantuje ich dlhú životnosť a odolnosť. Pozornosť si zaslúži aj séria kľučiek **smart2lock**, kde kovania disponujú integrovanou inteligentnou technológiou uzamykania. Tento inovatívny systém eliminuje potrebu rozety s mechanickým kľúčom, čím prináša moderný a elegantný dizajn.

MP KOVANIA - to je nekonečný výber kľučiek - stačí si vybrať tú správnu!



POMOCNÉ PRAVÍTKO

96
92
88
85

90

72

Typ otvoru a rozteč (vzdialenosť medzi osou kľučky a osou kľúča) sú vyrábané na objednávku podľa typu zámku.

Štandardná rozteč je 72 alebo 90 mm.
Na objednávku je možné vyraziť rozteč 85, 88, 92 alebo 96 mm.

Uvedená informácia platí len pre štítové kovania. Pri rozetovom kovaní sa neurčuje rozteč.

0

Rozteč

Vzdialenosť medzi osou kľučky a osou kľúča (BB, PZ a WC)

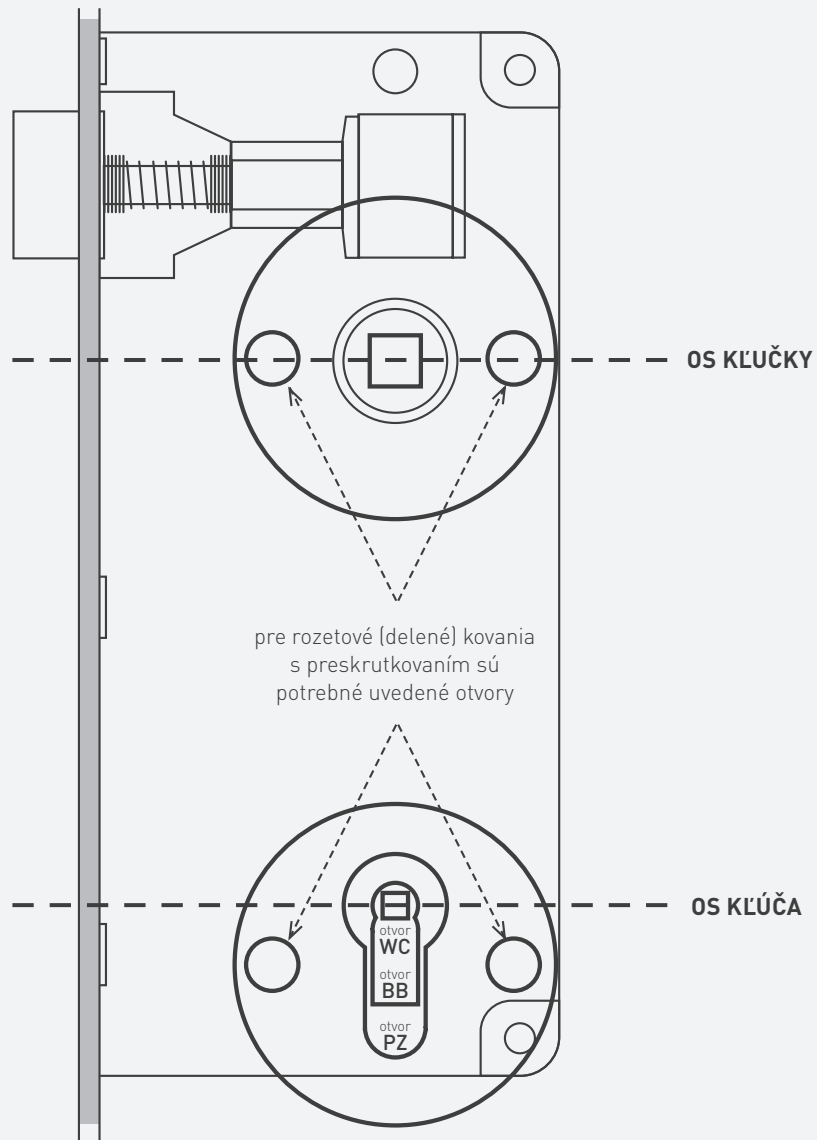

NIEKOĽKO RÁD PRED ZAKÚPENÍM KĽUČIEK

ROZETOVÉ KĽUČKY

Rozetové, čiže delené kľučky sú označované podľa tvaru skratkou R (okrhla rozeta), HR (hraná rozeta). Nakoľko sa väčšina rozetových kľučiek upevňuje preskrutkovaním cez celú hrúbku dverí v mieste zámku, je potrebné, aby boli v zámku na to určené otvory. Tie sú znázornené v nákrese na predchádzajúcej strane pri pomocnom pravítku.

TYPY OTVOROV



Skratka BB

označuje otvor pre interiérový kľúč (dôzický) v oválnom tvare



Skratka PZ

označuje otvor pre cylindrickú vložku (fabku)



Skratka WC

označuje WC sadu s kľúčom (k WC sade je potrebný zámok so spodným otvorom na štvorhran s rozmerom 6 x 6 mm)

KĽUČKY S UZAMYKANÍM SMART2LOCK

Pri kľučkách s označením **smart2Lock (S2L)** je potrebné uviesť, či ide pravú o kľučku (označujeme Re) alebo ľavú (označujeme Li).

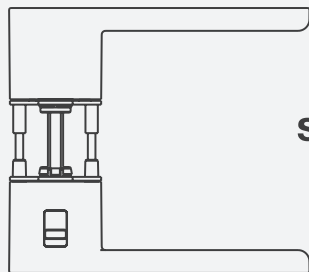

kľučka pravá (Re)

smart2lock
by GRIFFWERK

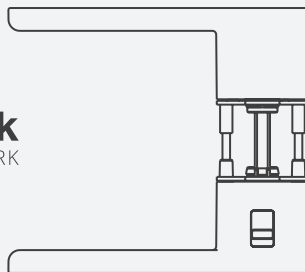

kľučka ľavá (Li)

AKO SPRÁVNE OBJEDNÁVAŤ

Pre rýchle a správne vybavenie objednávky je dôležité uviesť parametre špecifické pre rozetové a štítové kľučky.

Rozetové kľučky (delené)

- **názov modelu:** napr. GK - Lucia Piata S - R
- **povrch:** napr. NEM - nerez matná
- **typ otvoru:** BB, PZ, WC alebo kľučka s uzamykaním
- **prevedenie:** kľučka/kľučka
- **orientácia kľučky:** v prípade kľučky s uzamykaním (S2L) uviesť, či je kľučka ľavá Li alebo pravá Re
- **počet kusov**

Štandardne je kovanie dodávané so skrutkami a štvorhranom (8 x 8 mm) pre hrúbku dverí 40 mm. Pri hrubších dverách je potrebné uviesť ich presný rozmer v objednávke.

Pre expresné vybavenie vašej objednávky odporúčame navštíviť náš e-shop www.mp-kovania.sk a realizovať objednávku pohodlne online.



mp-kovania.sk
e-shop

POVRCHOVÉ ÚPRAVY

Pri produktoch ponúkame širokú škálu povrchových úprav, pričom sú použité najmodernejšie technológie a materiály, ktoré zaručujú dlhú životnosť a odolnosť povrchu. Napriek tomu nie každá povrchová úprava je vhodná do každého prostredia. Pri jednotlivých povrchových úpravách sme vyznačili vhodnosť použitia symbolom:



Nízka záťaž

Vhodné do interiérov s nízkou frekvenciou pohybu ľudí, napr. byty, rodinné domy a pod.



Stredná záťaž

Vhodné do interiérov so zvýšenou frekvenciou pohybu ľudí, napr. ubytovne, penzióny, hotely, kancelárie a pod.



Vysoká záťaž

Vhodné do interiérov s vysokou frekvenciou pohybu ľudí, napr. administratívne priestory, nemocnice, predajne, čerpacie stanice, nákupné centrá a pod. Taktiež do exteriérov a v niektorých prípadoch aj do prostredia so zvýšenou vlhkosťou.

! **UPOZORENIE:** Povrchové úpravy skutočných produktov nemusia byť totožné s grafikou uvedenou v katalógu.

POVRCHOVÉ ÚPRAVY



 **BIM** - BIELA MATNÁ



 **NEM** - NEREZ MATNÁ



 **NIM** - NIKEL MATNÝ



 **ZLM** - ZLATÁ MATNÁ



 **ANM** - ANTRACIT MATNÝ



 **CIM** - ČIERNA MATNÁ

PRAKTICKÉ INFORMÁCIE

Balenie tovaru

Balenie obsahuje dverné kovanie, doplnky, návod na montáž, potrebné skrutky, imbusové kľúče, prípadne šablónu na montáž kovania. Každý produkt je zabalený do ochranného obalu, ktorým je chránený voči poškodeniu pri manipulácii, resp. preprave.

Montáž

Montáž je veľmi dôležitá súčasť ovplyvňujúca funkčnosť výrobku. Z toho dôvodu je potrebné klásť zvýšený dôraz na jej správnosť. Pri kľučkách je dôležité dôkladné, presné a priame zameranie otvorov. Otvory odporúčame vrtať až po dodaní tovaru, nakoľko údaje v katalógu sú informatívne. Neupravujte výrobky pri montáži a použite na montáž príslušné diely, ktoré sa nachádzajú v balení.

Pred inštaláciou kľučky je potrebné premazať mechaniku kovania univerzálnym mazivom, napr. PECOL BIO SPRAY.

Ošetrovanie

Na čistenie a ošetrovanie sa neodporúča používať agresívne chemikálie ani čistiace prostriedky. Kovanie je potrebné čistiť len mäkkou, vlhkou handrou.

Po inštalácii odporúčame raz ročne premazať mechaniku kovania. Pri vydávaní neštandardných (pískavých) zvukov, alebo pri zasekávaní mechaniky, sa odporúča použiť univerzálne mazivo PECOL BIO SPRAY – Inovatívne viacúčelové, biologicky rozložiteľné mazivo s aktívnou penou. Vhodné na priemyselné, profesionálne i domáce použitie. Eliminuje koróziu, vznik nečistôt a vodného kameňa, zlepšuje povrchové vlastnosti a funkčnosť.



REKLAMÁCIA A ZÁRUKA

Záruka a garancia kvality

Na produkty sa vzťahuje štandardná 2-ročná záruka, ktorá začína plynúť dátumom predaja uvedenom na pokladničnom doklade alebo faktúre.

Záruka sa nevzťahuje na poškodenie výrobku nesprávnym ošetrovaním, opotrebovanie výrobku používaním, mechanickým poškodením (napr. kľúčmi, prstienkami a pod.), ani na výrobky, ktoré boli po zakúpení dodatočne upravované zákazníkom alebo jeho montážnikom, či umiestnené do nevhodného prostredia. Rovnako sa záruka nevzťahuje na znehodnotenie výrobku nekvalitnou montážou, nesprávnou manipuláciou, vlastnou prepravou a poškodenie prírodným živlom.

Pri dodržiavaní vyššie uvedených pokynov a upozornení je garantovaná dlhodobá životnosť výrobkov.

Výmena tovaru

Každý produkt je zabalený do ochranného obalu, ktorým je chránený voči poškodeniu pri manipulácii, resp. preprave. **Pri zistení vady alebo nedostatku, z ktorého vyplýva nárok na výmenu alebo reklamáciu produktu, je potrebné jednotlivé diely zabaliť tak, aby nedošlo k ich ďalšiemu poškodeniu a doručiť ich na adresu MP KOVANIA.**

CENY

Ceny v katalógu sú platné v čase vydania katalógu. Sú uvedené za kompletný výrobok, v prípade kľúčiek za set bez DPH v € alebo s 20% DPH v €. Prostredníctvom QR kódu, ktorý nájdete pri každom produkte, si rýchlo a jednoducho môžete overiť aktuálnu cenu, dostupnosť tovaru a ďalšie dôležité informácie.

Z dôvodu nestability cien materiálov na svetovom trhu si vyhradujeme právo na úpravu cien bez predošlého upozornenia.

Prepravné podmienky pre obchodných partnerov v rámci SR:

Pri odbere tovaru **na faktúru** v hodnote nižšej ako 100,00 € bez DPH po zľave bude k cene tovaru pripočítané prepravné a balné vo výške **5,00 € bez DPH**.

Pri odbere tovaru **na dobierku** v hodnote nižšej ako 100,00 € bez DPH po zľave bude k cene tovaru pripočítané prepravné a balné vo výške **6,50 € bez DPH**.

Pri odbere tovaru v hodnote nad **100,00 € bez DPH** po zľave je prepravné a balné **ZADARMO!** Prepravné mimo SR a za nadrozmerné zásielky je stanovené individuálne.

Kompletný sortiment s aktuálnymi cenami nájdete vždy na www.mp-kovania.sk.



Po načítaní QR kódu pri produkte budete presmerovaný **priamo na vybraný produkt** v našom e-shope.

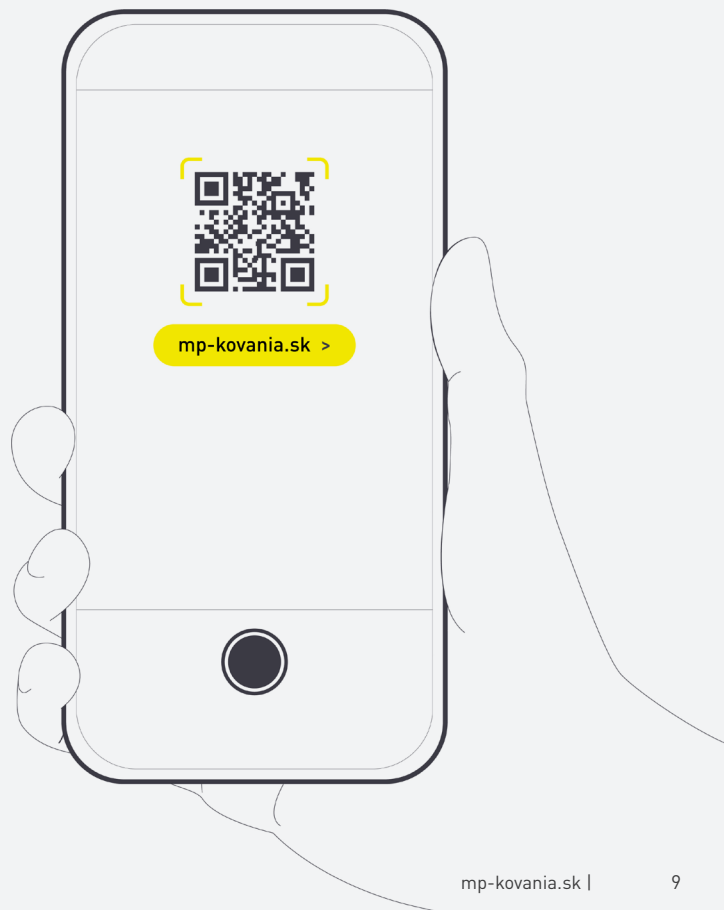



Príslušenstvo pre rôzne typy zámkov



Otvory pre vŕtanie rozetových kľučiek



Otvory pre vŕtanie roziet

KVALITNE NAMONTOVANÁ KLÚČKA – ZÁRUKA DLHODOBEJ ŽIVOTNOSTI

Vzhľadom k dôležitosti správnej montáže kľučiek dávame do pozornosti **MP – PROFI Šablónu**. Umožňuje presne a kolmo vyvŕtať otvory, a preto sa odporúča používať pri montáži všetkých rozetových kľučiek s výstupkami. MP – PROFI Šablónu je možné nastaviť na rôzne rozteče zadlabávacích zámkov. Umožňuje rýchlo reagovať na rôzne montážne situácie, nakoľko obsahuje všetky potrebné nástavce pre montáž, vrátane vrtáku s priemerom 7 mm. Je dostupná k zakúpeniu alebo k zapožičaniu.

MP – PROFI Šablóna

- Rýchla a **jednoduchá** montáž kľučky
- Zaručená **presnosť** vŕtania
- Garancia **kolmého** vŕtania
- **Nastaviteľnosť** roztečí
- **Univerzálnosť použitia** pre BB, PZ a WC

	Cena v € bez DPH	Cena v € s DPH
MP – PROFI Šablóna	100,00	120,00
Zapožičanie na 1 deň	10,00	12,00



GRIFFWERK

KĽUČKY NA DVERE
S INTEGROVANÝM UZAMYKANÍM

VYSVETLIVKY



obsahuje vratný mechanizmus
kľučky - pružinu



súčasťou balenia je sada skrutiek
na preskrutkovanie cez dvere



rozeta s výstupkami (zabraňuje
nežiadanému pohybu rozety na dverách)



kľučka nie je pravo-ľavá

KONŠTRUKCIA KĽUČIEK

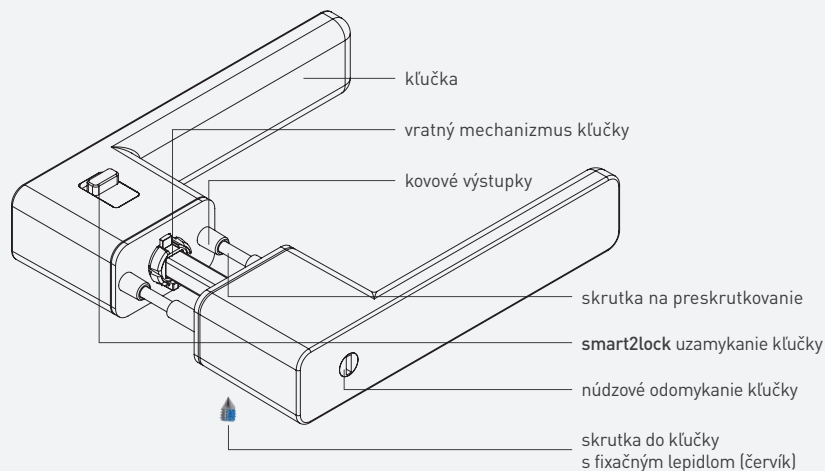

smart2lock
by GRIFFWERK

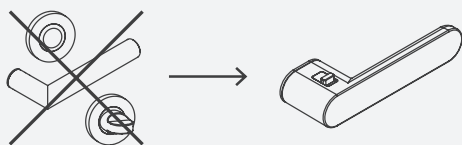

PREVEDENIA ROZIET

MINIMAL

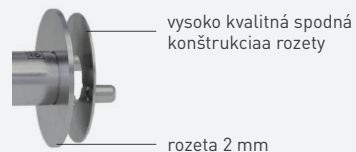

Kľučky MINIMAL
nájdate na stranách
24 - 33

KLIP

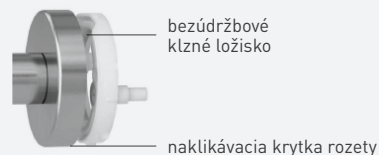

Kľučky KLIP
nájdate na stranách
34 - 38

PROFESIONAL



Kľučky PROFESIONAL
nájdate na stranách
40 - 48

ZAMYKANIE A ODOMYKANIE KĽUČIEK S2L



Zamykanie pre kľučky smart2lock R8 a AVUS ONE

Núdzové odomykanie
z druhej strany dverí



Zamykanie pre kľučky smart2lock R a HR

Núdzové odomykanie
z druhej strany dverí

[NIM] Nikel matný

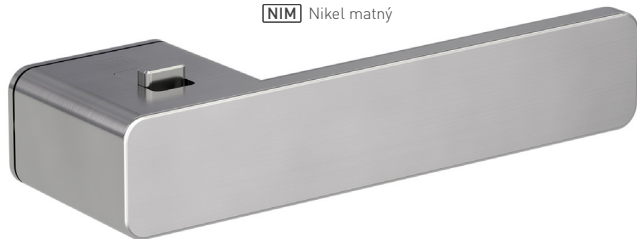

[BIM] Biela matná

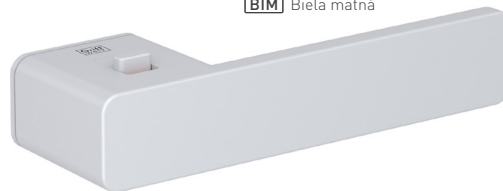

[ANM] Antracit matný

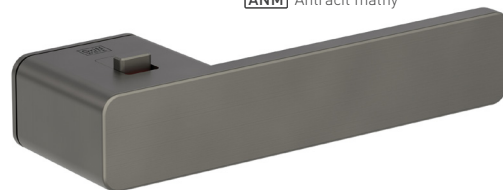

[CIM] Čierna matná

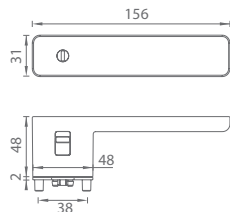

smart2lock
by GRIFFWERK

MATERIÁL: ZAMAK

i Štandardné balenie setu obsahuje sadu pre hrúbku dverí od 38 do 45 mm



**OVERTE
CENU**

GK - R8 ONE - S2L	NIM		ANM, CIM		BIM	
	bez DPH	s DPH	bez DPH	s DPH	bez DPH	s DPH
Cena za set v €						
kľ./kľ. s uzamykaním Li	161,50	193,80	170,00	204,00	170,00	204,00
kľ./kľ. s uzamykaním Re	161,50	193,80	170,00	204,00	170,00	204,00
sada predĺženia pre hrúbku dverí 45-50 mm	26,00	31,20	26,00	31,20	26,00	31,20
sada predĺženia pre hrúbku dverí 50-55 mm	26,00	31,20	26,00	31,20	26,00	31,20
sada predĺženia pre hrúbku dverí 55-60 mm	26,00	31,20	26,00	31,20	26,00	31,20





Griffwerk

[NIM] Nikel matný



[BIM] Biela matná

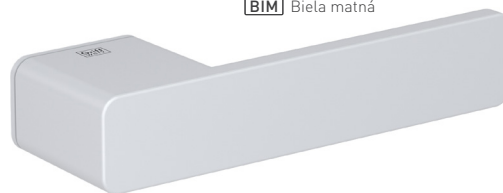

[ANM] Antracit matný

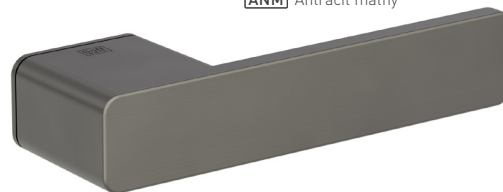

[CIM] Čierna matná

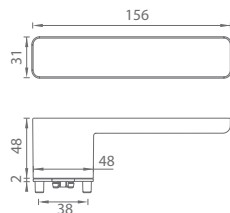



MATERIÁL: ZAMAK



OVERTE
CENU

GK - R8 ONE

	Cena za set v €	NIM		ANM, CIM		BIM	
		bez DPH	s DPH	bez DPH	s DPH	bez DPH	s DPH
kľ./kľ. bez spodnej rozety		118,00	141,60	126,00	151,20	126,00	151,20
kľ./kľ. + rozety BB		150,00	180,00	161,00	193,20	-	-
kľ./kľ. + rozety PZ		150,00	180,00	161,00	193,20	-	-
kľ./kľ. + rozety s WC kľúčom		173,50	208,20	184,50	221,40		





NIM Nikel matný



ZLM Zlatá matná



ANM Antracit matný

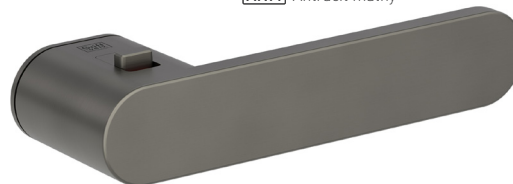

CIM Čierna matná

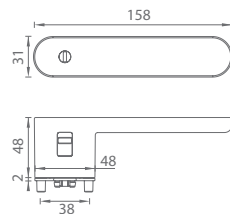

smart2lock
by GRIFFWERK

MATERIÁL: ZAMAK

i Štandardné balenie setu obsahuje sadu pre hrúbku dverí od 38 do 45 mm



**OVERTE
CENU**

GK - AVUS ONE - S2L	NIM		ANM, CIM		ZLM	
	bez DPH	s DPH	bez DPH	s DPH	bez DPH	s DPH
Cena za set v €						
kľ./kľ. s uzamykaním Li	161,50	193,80	170,00	204,00	220,50	264,60
kľ./kľ. s uzamykaním Re	161,50	193,80	170,00	204,00	220,50	264,60
sada predĺženia pre hrúbku dverí 45-50 mm	26,00	31,20	26,00	31,20	26,00	31,20
sada predĺženia pre hrúbku dverí 50-55 mm	26,00	31,20	26,00	31,20	26,00	31,20
sada predĺženia pre hrúbku dverí 55-60 mm	26,00	31,20	26,00	31,20	26,00	31,20





Griff
werk

NIM Nikel matný



ZLM Zlatá matná



ANM Antracit matný

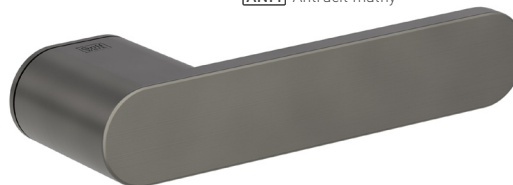

CIM Čierna matná

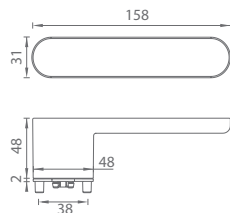

MATERIÁL: ZAMAK



**OVERTE
CENU**

GK - AVUS ONE

	Cena za set v €	NIM		ANM, CIM		ZLM	
		bez DPH	s DPH	bez DPH	s DPH	bez DPH	s DPH
kľ./kľ. bez spodnej rozety		118,00	141,60	126,00	151,20	177,00	212,40
kľ./kľ. + rozety BB		150,00	180,00	161,00	193,20	-	-
kľ./kľ. + rozety PZ		150,00	180,00	161,00	193,20	-	-
kľ./kľ. + rozety s WC kľúčom		173,00	207,60	184,50	221,40		





MATERIÁL: ZAMAK

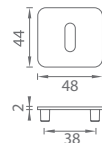

ROZETA BB

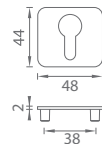

ROZETA PZ

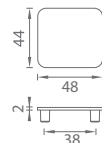

ZÁSLEPKA



NIM Nikel matný

ANM Antracit matný

CIM Čierna matná



GK - ROZETY ONE

	Cena za set v €	NIM		ANM, CIM	
		bez DPH	s DPH	bez DPH	s DPH
rozety BB		32,00	38,40	35,00	42,00
rozety PZ		32,00	38,40	35,00	42,00
záslepka		32,00	38,40	35,00	42,00

OVERTE
CENU





NIM Nikel matný



ANM Antracit matný

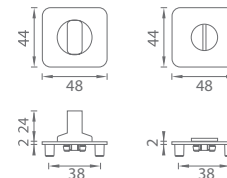

ROZETY WC



CIM Čierna matná



OVERTE
CENU

GK - ROZETY ONE WC

	Cena za set v €	NIM		ANM, CIM	
		bez DPH	s DPH	bez DPH	s DPH
rozety s WC kľúčom 		55,50	66,60	58,50	70,20



MATERIÁL: ZAMAK

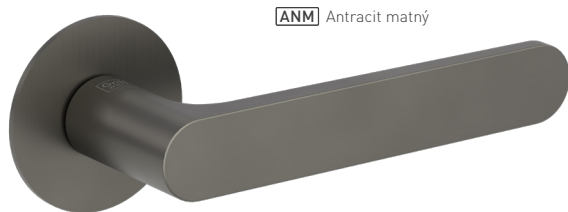

ANM Antracit matný

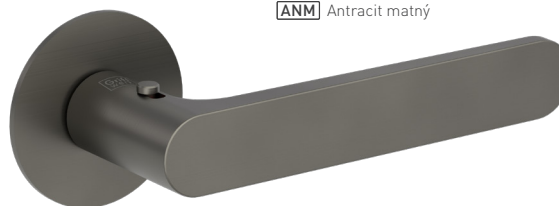
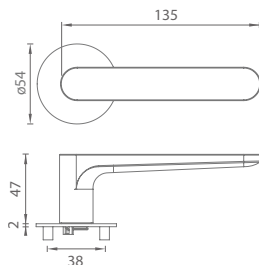

ANM Antracit matný

smart2lock
by GRIFFWERK

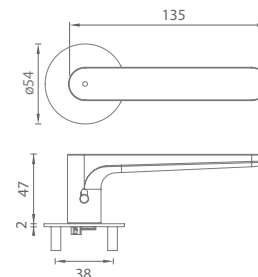

i Standardné balenie setu obsahuje sadu pre hrúbku dverí od 38 do 45 mm



OVERTE
CENU

GK - AVUS PIATTA S - R

	Cena za set v €	bez DPH	s DPH
kľ./kľ. bez spodnej rozety		78,00	93,60
kľ./kľ. + rozety BB		84,00	100,80
kľ./kľ. + rozety PZ		84,00	100,80
kľ./kľ. + rozety s WC kľúčom		108,00	129,60



GK - AVUS PIATTA S - R S UZAMYKANÍM

	Cena za set v €	bez DPH	s DPH
kľ./kľ. s uzamykaním Li		108,00	129,60
kľ./kľ. s uzamykaním Re		108,00	129,60



	Kľučka na dvere str. 24		Kľučka na eurookno str. 52
--	----------------------------	--	----------------------------------



MATERIÁL: ZAMAK



CIM Čierna matná

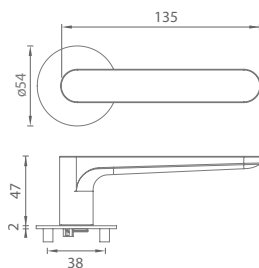

CIM Čierna matná

smart2lock
by GRIFFWERK

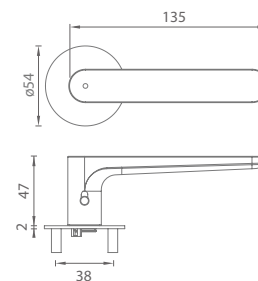

i Standardné balenie setu obsahuje sadu pre hrúbku dverí od 38 do 45 mm



OVERTE CENU

GK - AVUS PIATTA S - R

	Cena za set v €	bez DPH	s DPH
kľ./kľ. bez spodnej rozety		78,00	93,60
kľ./kľ. + rozety BB		84,00	100,80
kľ./kľ. + rozety PZ		84,00	100,80
kľ./kľ. + rozety s WC kľúčom		108,00	129,60



GK - AVUS PIATTA S - R S UZAMYKANÍM

	Cena za set v €	bez DPH	s DPH
kľ./kľ. s uzamykaním Li		108,00	129,60
kľ./kľ. s uzamykaním Re		108,00	129,60



	Kľučka na dvere str. 26		Kľučka na eurookno str. 52
--	-----------------------------------	--	--------------------------------------



MATERIÁL: NEREZ

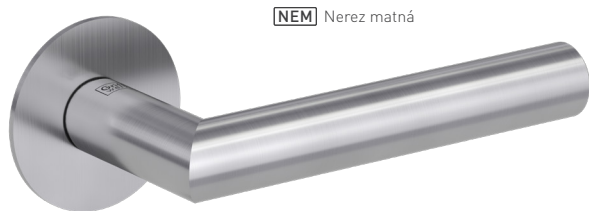

NEM Nerez matná

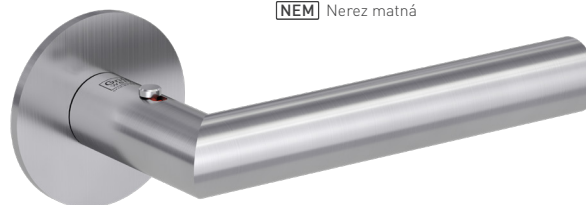
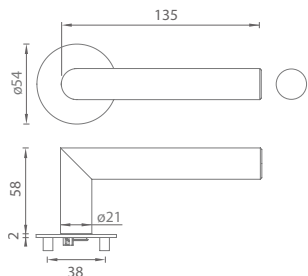

NEM Nerez matná

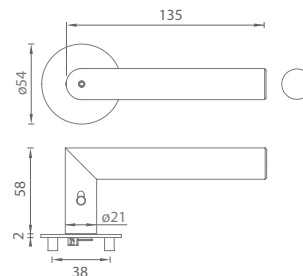

smart2lock
by GRIFFWERK

i Štandardné balenie setu obsahuje sadu pre hrúbku dverí od 38 do 45 mm



OVERTE
CENU

GK - LUCIA PIATTA S - R

	Cena za set v €	bez DPH	s DPH
kľ./kľ. bez spodnej rozety		57,00	68,40
kľ./kľ. + rozety BB		63,00	75,60
kľ./kľ. + rozety PZ		63,00	75,60
kľ./kľ. + rozety s WC kľúčom		87,00	104,40



GK - LUCIA PIATTA S - R S UZAMYKANÍM

	Cena za set v €	bez DPH	s DPH
kľ./kľ. s uzamykaním Li		87,00	104,40
kľ./kľ. s uzamykaním Re		87,00	104,40



	Kľučka na dvere str. 28, 34, 40		Kľučka na eurookno str. 52
--	------------------------------------	---	----------------------------------



CIM Čierna matná

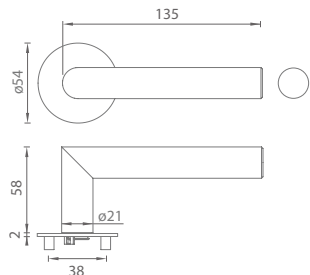

CIM Čierna matná

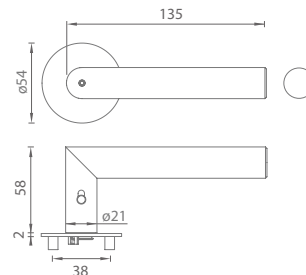

smart2lock
by GRIFFWERK

i Štandardné balenie setu obsahuje sadu pre hrúbku dverí od 38 do 45 mm

MATERIÁL: NEREX



OVERTE
CENU

GK - LUCIA PIATTA - R

	Cena za set v €	bez DPH	s DPH
kľ./kľ. bez spodnej rozety		63,50	76,20
kľ./kľ. + rozety BB		69,50	83,40
kľ./kľ. + rozety PZ		69,50	83,40
kľ./kľ. + rozety s WC kľúčom		93,50	112,20



GK - LUCIA PIATTA - R S UZAMYKANÍM

	Cena za set v €	bez DPH	s DPH
kľ./kľ. s uzamykaním Li		93,50	112,20
kľ./kľ. s uzamykaním Re		93,50	112,20



	Kľučka na dvere str. 29, 35, 41		Kľučka na eurookno str. 52
--	------------------------------------	---	----------------------------------

MATERIÁL: NEREZ



NEM Nerez matná

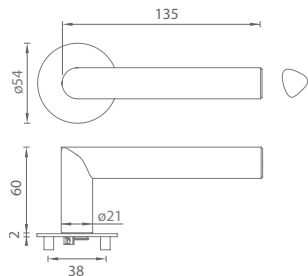

NEM Nerez matná

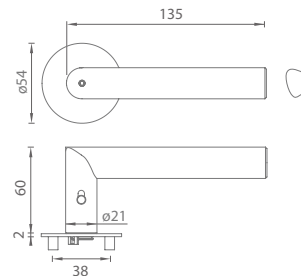

smart2lock
by GRIFFWERK

i Štandardné balenie setu obsahuje sadu pre hrúbku dverí od 38 do 45 mm



OVERTE
CENU

GK - TRI 134 PIATTA - R

	Cena za set v €	bez DPH	s DPH
kľ./kľ. bez spodnej rozety		63,50	76,20
kľ./kľ. + rozety BB		69,50	83,40
kľ./kľ. + rozety PZ		69,50	83,40
kľ./kľ. + rozety s WC kľúčom		93,50	112,20



GK - TRI 134 PIATTA - R S UZAMYKANÍM

	Cena za set v €	bez DPH	s DPH
kľ./kľ. s uzamykaním Li		93,50	112,20
kľ./kľ. s uzamykaním Re		93,50	112,20



	Kľučka na dvere str. 30, 42		Kľučka na eurookno str. 54
--	--------------------------------	--	----------------------------------

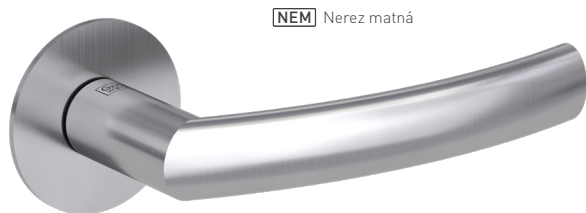

NEM Nerez matná

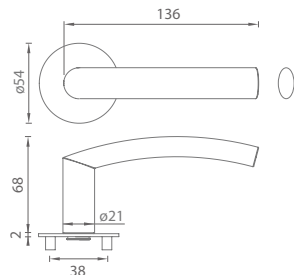

NEM Nerez matná

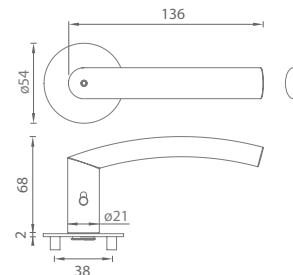

smart2lock
by GRIFFWERK

i Štandardné balenie setu obsahuje sadu pre hrúbku dverí od 38 do 45 mm

MATERIÁL: NEREZ



OVERTE
CENU

GK - LORITA PIATTA - R

	Cena za set v €	bez DPH	s DPH
kľ./kľ. bez spodnej rozety		63,50	76,20
kľ./kľ. + rozety BB		69,50	83,40
kľ./kľ. + rozety PZ		69,50	83,40
kľ./kľ. + rozety s WC kľúčom		93,50	112,20



GK - LORITA PIATTA - R S UZAMYKANÍM

	Cena za set v €	bez DPH	s DPH
kľ./kľ. s uzamykaním Li		93,50	112,20
kľ./kľ. s uzamykaním Re		93,50	112,20



	Kľučka na dvere str. 31, 36, 46		Kľučka na eurookno str. 54
--	---	--	--------------------------------------

MATERIÁL: NEREZ



NEM Nerez matná

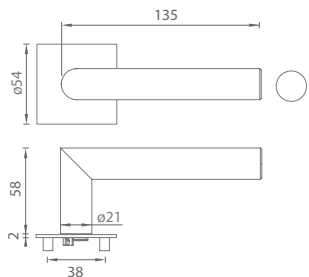

NEM Nerez matná

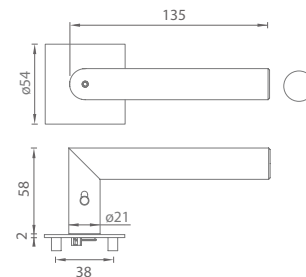

smart2lock
by GRIFFWERK

i Standardné balenie setu obsahuje sadu pre hrúbku dverí od 38 do 45 mm



**OVERTE
CENU**

GK - LUCIA PIATTA S QUATTRO - HR

	Cena za set v €	bez DPH	s DPH
kľ./kľ. bez spodnej rozety		63,50	76,20
kľ./kľ. + rozety BB		69,50	83,40
kľ./kľ. + rozety PZ		69,50	83,40
kľ./kľ. + rozety s WC kľúčom		93,50	112,20



GK - LUCIA PIATTA S QUATTRO - HR S UZAMYKANÍM

	Cena za set v €	bez DPH	s DPH
kľ./kľ. s uzamykaním Li		93,50	112,20
kľ./kľ. s uzamykaním Re		93,50	112,20





CIM Čierna matná

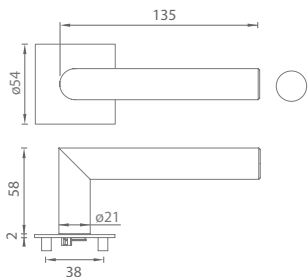

CIM Čierna matná

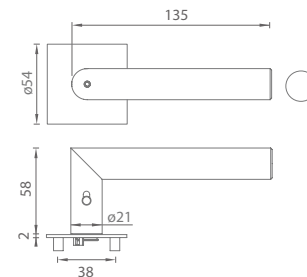

smart2lock
by GRIFFWERK

i Standardné balenie setu obsahuje sadu pre hrúbku dverí od 38 do 45 mm

MATERIÁL: NEREZ



OVERTE
CENU

GK - LUCIA PIATTA S QUATTRO - HR

	Cena za set v €	bez DPH	s DPH
kľ./kľ. bez spodnej rozety		70,00	84,00
kľ./kľ. + rozety BB		76,00	91,20
kľ./kľ. + rozety PZ		76,00	91,20
kľ./kľ. + rozety s WC kľúčom		100,00	120,00



GK - LUCIA PIATTA S QUATTRO - HR S UZAMYKANÍM

	Cena za set v €	bez DPH	s DPH
kľ./kľ. s uzamykaním Li		100,00	120,00
kľ./kľ. s uzamykaním Re		100,00	120,00



MATERIÁL: NEREZ



NEM Nerez matná

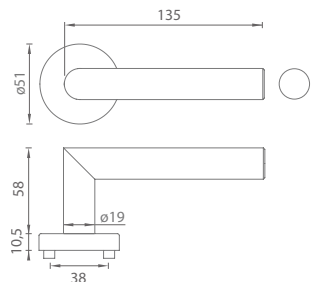

NEM Nerez matná

smart2lock
by GRIFFWERK

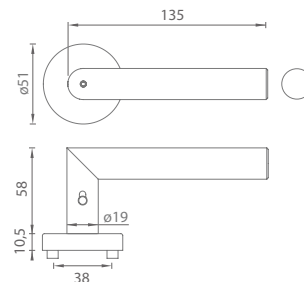

i Štandardné balenie setu obsahuje sadu pre hrúbku dverí od 38 do 45 mm



OVERTE
CENU

GK - LUCIA - R

	Cena za set v €	bez DPH	s DPH
kľ./kľ. bez spodnej rozety		22,50	27,00
kľ./kľ. + rozety BB		28,50	34,20
kľ./kľ. + rozety PZ		28,50	34,20
kľ./kľ. + rozety s WC kľúčom		46,00	55,20



GK - LUCIA - R S UZAMYKANÍM

	Cena za set v €	bez DPH	s DPH
kľ./kľ. s uzamykaním Li		46,00	55,20
kľ./kľ. s uzamykaním Re		46,00	55,20



	Kľučka na dvere str. 28, 34, 40		Kľučka na eurookno str. 52
--	------------------------------------	--	----------------------------------



CIM Čierna matná

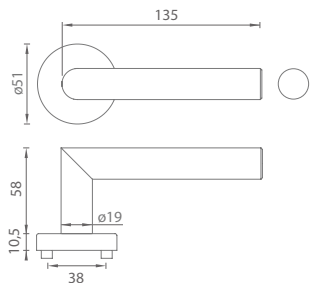

CIM Čierna matná

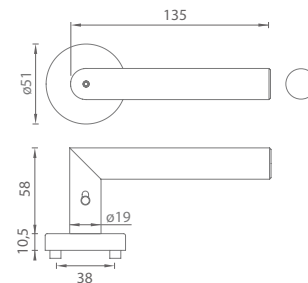

smart2lock
by GRIFFWERK

i Štandardné balenie setu obsahuje sadu pre hrúbku dverí od 38 do 45 mm

MATERIÁL: NEREZ



OVERTE
CENU

GK - LUCIA - R

	Cena za set v €	bez DPH	s DPH
kľ./kľ. bez spodnej rozety		39,00	46,80
kľ./kľ. + rozety BB		45,00	54,00
kľ./kľ. + rozety PZ		45,00	54,00
kľ./kľ. + rozety s WC kľúčom		62,50	75,00



GK - LUCIA - R S UZAMYKANÍM

	Cena za set v €	bez DPH	s DPH
kľ./kľ. s uzamykaním Li		62,50	75,00
kľ./kľ. s uzamykaním Re		62,50	75,00



	Kľučka na dvere str. 29, 35, 41		Kľučka na eurookno str. 52
--	---	--	--------------------------------------

MATERIÁL: NEREZ



NEM Nerez matná

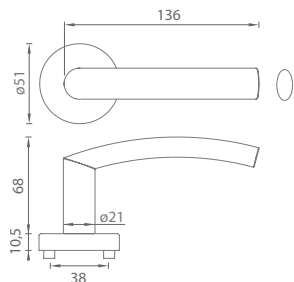

NEM Nerez matná

smart2lock
by GRIFFWERK

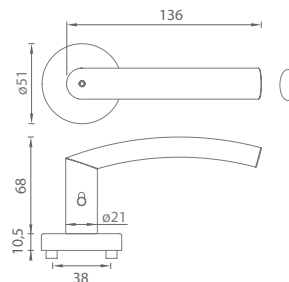

i Štandardné balenie setu obsahuje sadu pre hrúbku dverí od 38 do 45 mm



OVERTE
CENU

GK - LORITA - R

	Cena za set v €	bez DPH	s DPH
kľ./kľ. bez spodnej rozety		44,00	52,80
kľ./kľ. + rozety BB		49,50	59,40
kľ./kľ. + rozety PZ		49,50	59,40
kľ./kľ. + rozety s WC kľúčom		67,50	81,00



GK - LORITA - R S UZAMYKANÍM

	Cena za set v €	bez DPH	s DPH
kľ./kľ. s uzamykaním Li		67,50	81,00
kľ./kľ. s uzamykaním Re		67,50	81,00



	Kľučka na dvere str. 31, 36, 46		Kľučka na eurookno str. 54
--	------------------------------------	--	----------------------------------



MATERIÁL: NEREZ

NEM Nerez matná

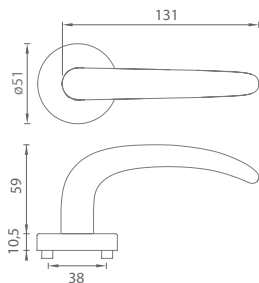

CIM Čierna matná

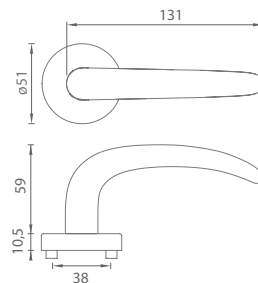

OVERTE CENU

GK - ULMER - R

	Cena za set v €	bez DPH	s DPH
kľ./kľ. bez spodnej rozety		47,50	57,00
kľ./kľ. + rozety BB		53,00	63,60
kľ./kľ. + rozety PZ		53,00	63,60
kľ./kľ. + rozety s WC kľúčom		71,00	85,20



Kľučka na dvere
str. 38



Kľučka na eurookno
str. 55



GK - ULMER - R

	Cena za set v €	bez DPH	s DPH
kľ./kľ. bez spodnej rozety		71,00	85,20
kľ./kľ. + rozety BB		76,50	91,80
kľ./kľ. + rozety PZ		76,50	91,80
kľ./kľ. + rozety s WC kľúčom		94,50	113,40



Kľučka na dvere
str. 38



Kľučka na eurookno
str. 55



max bill



MATERIÁL: NEREZ



NEM Nerez matná

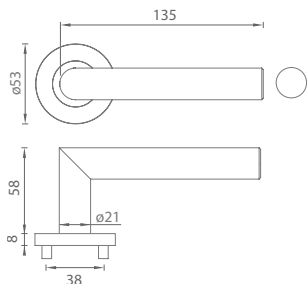

NEM Nerez matná

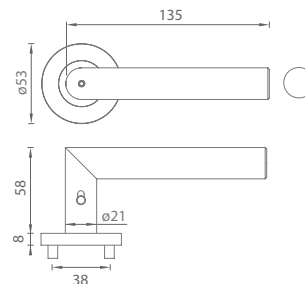

smart2lock
by GRIFFWERK

i Štandardné balenie setu obsahuje sadu pre hrúbku dverí od 38 do 45 mm



OVERTE
CENU

GK - LUCIA PROFESSIONAL - R

	Cena za set v €	bez DPH	s DPH
kľ./kľ. bez spodnej rozety		41,50	49,80
kľ./kľ. + rozety BB		47,50	57,00
kľ./kľ. + rozety PZ		47,50	57,00
kľ./kľ. + rozety s WC kľúčom		65,00	78,00



GK - LUCIA PROFESSIONAL - R S UZAMYKANÍM

	Cena za set v €	bez DPH	s DPH
kľ./kľ. s uzamykaním Li		65,00	78,00
kľ./kľ. s uzamykaním Re		65,00	78,00



	Kľučka na dvere str. 28, 34, 40		Kľučka na eurookno str. 52
--	------------------------------------	--	----------------------------------



CIM Čierna matná

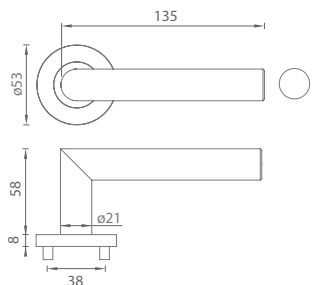

CIM Čierna matná

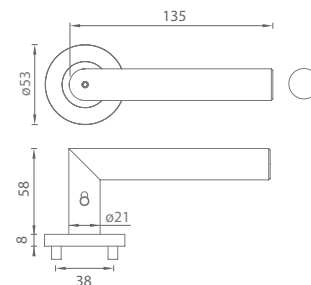

smart2lock
by GRIFFWERK

i Štandardné balenie setu obsahuje sadu pre hrúbku dverí od 38 do 45 mm

MATERIÁL: NEREX



OVERTE
CENU

GK - LUCIA PROFESSIONAL - R

	Cena za set v €	bez DPH	s DPH
kľ./kľ. bez spodnej rozety		67,50	81,00
kľ./kľ. + rozety BB		73,00	87,60
kľ./kľ. + rozety PZ		73,00	87,60
kľ./kľ. + rozety s WC kľúčom		91,00	109,20



GK - LUCIA PROFESSIONAL - R S UZAMYKANÍM

	Cena za set v €	bez DPH	s DPH
kľ./kľ. s uzamykaním Li		91,00	109,20
kľ./kľ. s uzamykaním Re		91,00	109,20



	Kľučka na dvere str. 29, 35, 41		Kľučka na eurookno str. 52
--	------------------------------------	---	----------------------------------

MATERIÁL: NEREZ



NEM Nerez matná

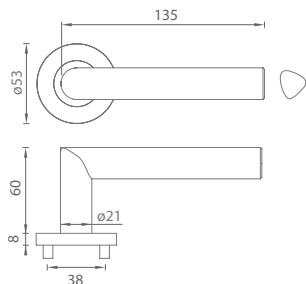

NEM Nerez matná

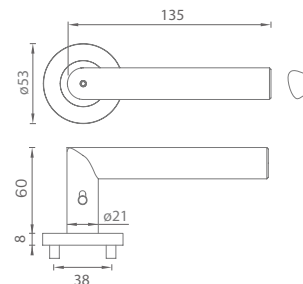

smart2lock
by GRIFFWERK

i Štandardné balenie setu obsahuje sadu pre hrúbku dverí od 38 do 45 mm



OVERTE
CENU

GK - TRI 134 - R

	Cena za set v €	bez DPH	s DPH
kľ./kľ. bez spodnej rozety		59,50	71,40
kľ./kľ. + rozety BB		65,50	78,60
kľ./kľ. + rozety PZ		65,50	78,60
kľ./kľ. + rozety s WC kľúčom		83,50	100,20



GK - TRI 134 - R S UZAMYKANÍM

	Cena za set v €	bez DPH	s DPH
kľ./kľ. s uzamykaním Li		83,50	100,20
kľ./kľ. s uzamykaním Re		83,50	100,20



	Kľučka na dvere str. 30, 42		Kľučka na eurookno str. 54
--	--------------------------------	--	----------------------------------



CIM Čierna matná

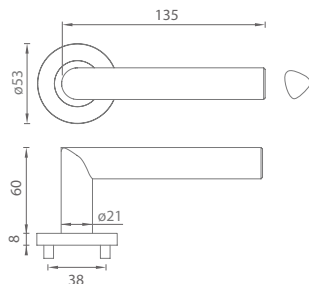

CIM Čierna matná

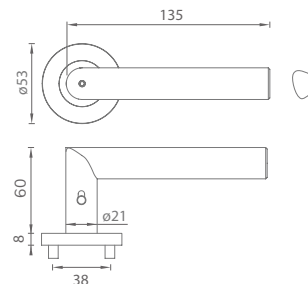

smart2lock
by GRIFFWERK

i Štandardné balenie setu obsahuje sadu pre hrúbku dverí od 38 do 45 mm

MATERIÁL: NEREZ



OVERTE
CENU

GK - TRI 134 - R

	Cena za set v €	bez DPH	s DPH
kľ./kľ. bez spodnej rozety		85,50	102,60
kľ./kľ. + rozety BB		91,50	109,80
kľ./kľ. + rozety PZ		91,50	109,80
kľ./kľ. + rozety s WC kľúčom		109,50	131,40



GK - TRI 134 - R S UZAMYKANÍM

	Cena za set v €	bez DPH	s DPH
kľ./kľ. s uzamykaním Li		109,50	131,40
kľ./kľ. s uzamykaním Re		109,50	131,40



MATERIÁL: NEREZ

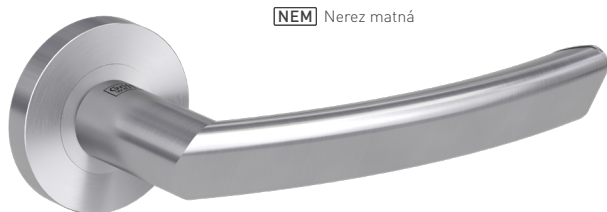

NEM Nerez matná

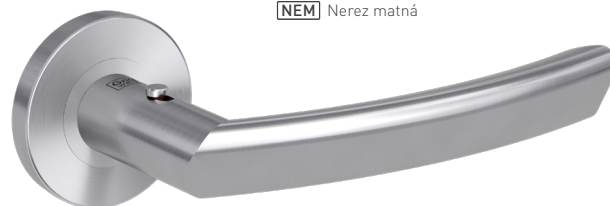
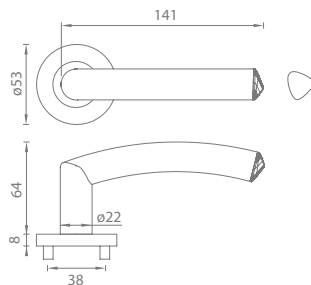

NEM Nerez matná

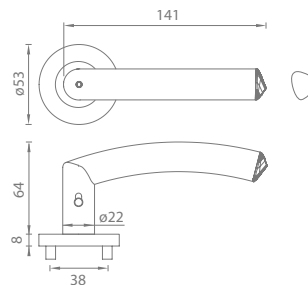

smart2lock
by GRIFFWERK

i Štandardné balenie setu obsahuje sadu pre hrúbku dverí od 38 do 45 mm



OVERTE
CENU

GK - CRYSTAL - R

	Cena za set v €	bez DPH	s DPH
kľ./kľ. bez spodnej rozety		59,50	71,40
kľ./kľ. + rozety BB		65,50	78,60
kľ./kľ. + rozety PZ		65,50	78,60
kľ./kľ. + rozety s WC kľúčom		83,50	100,20



GK - CRYSTAL - R S UZAMYKANÍM

	Cena za set v €	bez DPH	s DPH
kľ./kľ. s uzamykaním Li		83,50	100,20
kľ./kľ. s uzamykaním Re		83,50	100,20



JETTE 



Jette Jorg

MATERIÁL: NEREZ



NEM Nerez matná

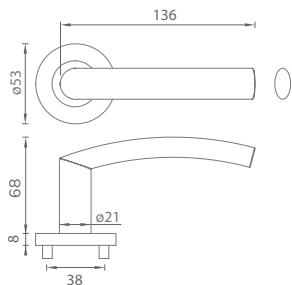

NEM Nerez matná

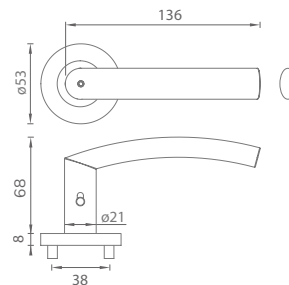

smart2lock
by GRIFFWERK

i Štandardné balenie setu obsahuje sadu pre hrúbku dverí od 38 do 45 mm



OVERTE
CENU

GK - LORITA PROFESSIONAL - R

	Cena za set v €	bez DPH	s DPH
kľ./kľ. bez spodnej rozety		58,50	70,20
kľ./kľ. + rozety BB		64,50	77,40
kľ./kľ. + rozety PZ		64,50	77,40
kľ./kľ. + rozety s WC kľúčom		82,00	98,40



GK - LORITA PROFESSIONAL - R S UZAMYKANÍM

	Cena za set v €	bez DPH	s DPH
kľ./kľ. s uzamykaním Li		82,00	98,40
kľ./kľ. s uzamykaním Re		82,00	98,40



	Kľučka na dvere str. 31, 36, 46		Kľučka na eurookno str. 54
--	------------------------------------	--	----------------------------------



MATERIÁL: ZAMAK

CIM Čierna matná

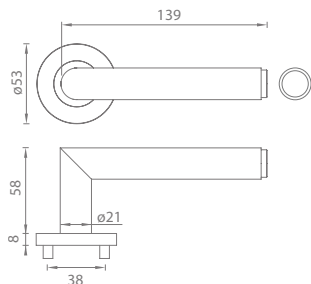

i V kombinácií - zlatá matná

CIM Čierna matná

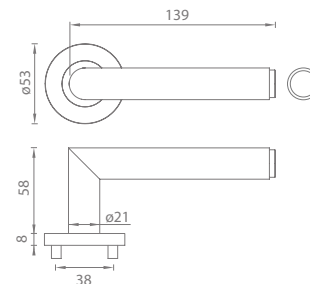

i V kombinácií - meď matná



OVERTE
CENU

GK - LUCIA SELECT - R

	Cena za set v €	bez DPH	s DPH
kľ./kľ. bez spodnej rozety		99,00	118,80
kľ./kľ. + rozety BB		105,00	126,00
kľ./kľ. + rozety PZ		105,00	126,00
kľ./kľ. + rozety s WC kľúčom		122,50	147,00



GK - LUCIA SELECT - R

	Cena za set v €	bez DPH	s DPH
kľ./kľ. bez spodnej rozety		99,00	118,80
kľ./kľ. + rozety BB		105,00	126,00
kľ./kľ. + rozety PZ		105,00	126,00
kľ./kľ. + rozety s WC kľúčom		122,50	147,00







GRIFFWERK

KĽUČKY NA OKNÁ

VYSVETLIVKY



súčasťou balenia sú 2 kusy metrických
skrutiek 5 x 40 mm

KONŠTRUKCIA A POUŽITIE KĽUČIEK NA EUROOKNO

KONŠTRUKCIA MECHANIKY NA EUROOKNO

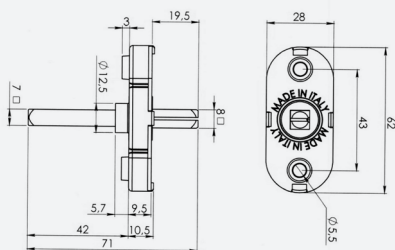

mechanika pre kľučku na eurookno

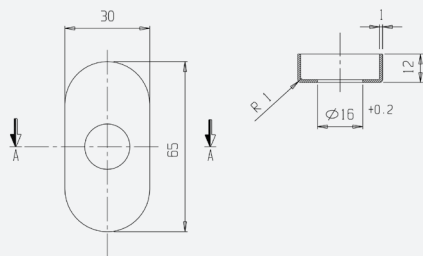

krytka mechaniky pre kľučku na eurookno

MOŽNOSTI POUŽITIA KĽUČIEK NA EUROOKNO



MATERIÁL: ZAMAK



ANM Antracit matný

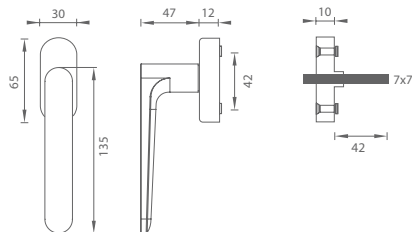

CIM Čierna matná

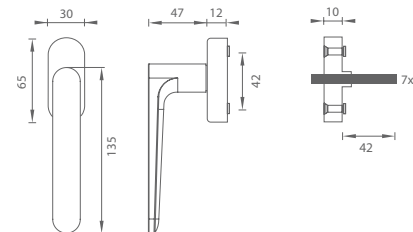

GK - AVUS - DKO

	Cena za set v €	bez DPH	s DPH
klučka na eurookno		51,00	61,20



GK - AVUS - DKO

	Cena za set v €	bez DPH	s DPH
klučka na eurookno		51,00	61,20



OVERTE CENU

	Kľučka na dvere str. 24		Kľučka na eurookno str. 52
--	----------------------------	--	-------------------------------

	Kľučka na dvere str. 26		Kľučka na eurookno str. 52
--	----------------------------	--	-------------------------------

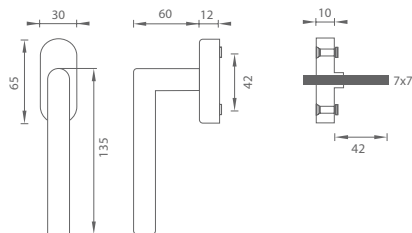

[NEM] Nerez matná

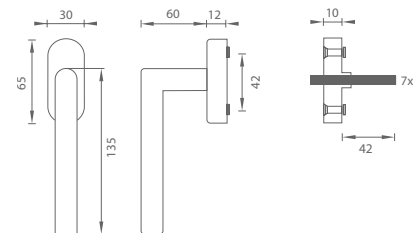

[CIM] Čierna matná

MATERIÁL: NEREZ



GK - LUCIA - DKO

	Cena za set v €	
	bez DPH	s DPH
klučka na eurookno	25,50	30,60



OVERTE
CENU

	Kľučka na dvere str. 28, 34, 40		Kľučka na eurookno str. 53
--	---	--	--------------------------------------

GK - LUCIA - DKO

	Cena za set v €	
	bez DPH	s DPH
klučka na eurookno	33,50	40,20



	Kľučka na dvere str. 29, 35, 41		Kľučka na eurookno str. 53
--	---	--	--------------------------------------

MATERIÁL: ZAMAK

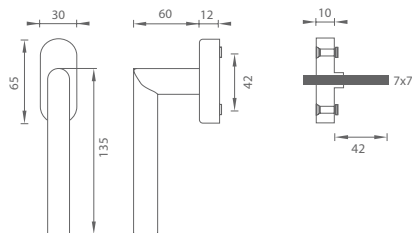

NEM Nerez matná

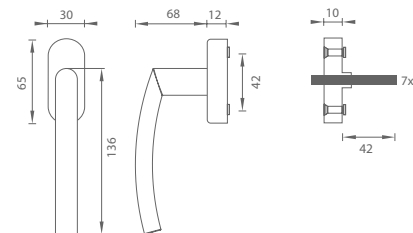

NEM Nerez matná



GK - TRI 134 - DKO

	Cena za set v €	bez DPH	s DPH
klučka na eurookno		43,50	52,20





GK - LORITA - DKO

	Cena za set v €	bez DPH	s DPH
klučka na eurookno		35,50	42,60



OVERTE CENU

	Kľučka na dvere str. 30, 42		Kľučka na eurookno str. 54
---	--------------------------------	---	-------------------------------

	Kľučka na dvere str. 31, 36, 46		Kľučka na eurookno str. 54
--	------------------------------------	---	-------------------------------

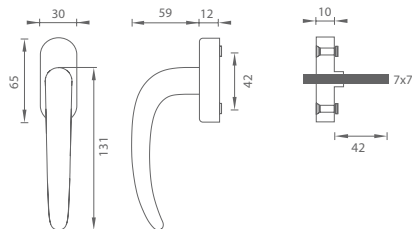

[NEM] Nerez matná

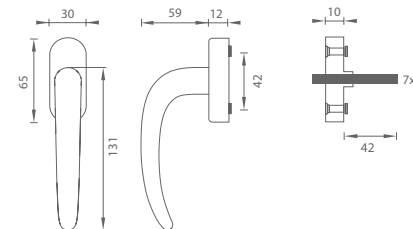

[CIM] Čierna matná

MATERIÁL: NEREZ



GK - ULMER - DKO

	Cena za set v €	
	bez DPH	s DPH
klučka na eurookno	37,50	45,00



OVERTE
CENU

	Kľučka na dvere str. 38		Kľučka na eurookno str. 55
--	----------------------------	--	----------------------------------

GK - ULMER - DKO

	Cena za set v €	
	bez DPH	s DPH
klučka na eurookno	48,50	58,20



	Kľučka na dvere str. 38		Kľučka na eurookno str. 55
--	----------------------------	--	----------------------------------

ABECEDNÝ ZOZNAM

GK - AVUS - DKO	52
GK - AVUS - DKO	52
GK - AVUS ONE	20
GK - AVUS ONE - S2L	18
GK - AVUS PIATTA S - R	24
GK - AVUS PIATTA S - R	26
GK - AVUS PIATTA S - R S UZAMYKANÍM	24
GK - AVUS PIATTA S - R S UZAMYKANÍM	26
GK - CRYSTAL - R	44
GK - CRYSTAL - R S UZAMYKANÍM	44
GK - FRAME CUBE	62
GK - LORITA - DKO	54
GK - LORITA PIATTA - R	31
GK - LORITA PIATTA - R S UZAMYKANÍM	31
GK - LORITA PROFESSIONAL - R	46
GK - LORITA PROFESSIONAL - R S UZAMYKANÍM	46
GK - LORITA - R	36
GK - LORITA - R S UZAMYKANÍM	36
GK - LUCIA - DKO	53
GK - LUCIA - DKO	53
GK - LUCIA PIATTA - R	29
GK - LUCIA PIATTA - R S UZAMYKANÍM	29
GK - LUCIA PIATTA S QUATTRO - HR	32
GK - LUCIA PIATTA S QUATTRO - HR	33
GK - LUCIA PIATTA S QUATTRO - HR S UZAMYKANÍM	32
GK - LUCIA PIATTA S QUATTRO - HR S UZAMYKANÍM	33
GK - LUCIA PIATTA S - R	28
GK - LUCIA PIATTA S - R S UZAMYKANÍM	28
GK - LUCIA PROFESSIONAL - R	40
GK - LUCIA PROFESSIONAL - R	41
GK - LUCIA PROFESSIONAL - R S UZAMYKANÍM	40
GK - LUCIA PROFESSIONAL - R S UZAMYKANÍM	41
GK - LUCIA - R	34
GK - LUCIA - R	35
GK - LUCIA - R S UZAMYKANÍM	34
GK - LUCIA - R S UZAMYKANÍM	35
GK - LUCIA SELECT - R	48
GK - LUCIA SELECT - R	48
GK - PURISTO	64
GK - PURISTO	65
GK - PURISTO S UZAMYKANÍM	64
GK - PURISTO S UZAMYKANÍM	65
GK - R8 ONE	16
GK - R8 ONE - S2L	14

GK - ROZETY ONE	22
GK - ROZETY ONE WC	23
GK - TRI 134 - DKO	54
GK - TRI 134 PIATTA - R	30
GK - TRI 134 PIATTA - R S UZAMYKANÍM	30
GK - TRI 134 - R	42
GK - TRI 134 - R	43
GK - TRI 134 - R S UZAMYKANÍM	42
GK - TRI 134 - R S UZAMYKANÍM	43
GK - ULMER - DKO	55
GK - ULMER - DKO	55
GK - ULMER - R	38
GK - ULMER - R	38



Griffwerk

Griffwerk



MP[®]
KOVANIA

S VAMI OD ROKU 2002

MP KOVANIA®

KOVANIA NA DVERE, STAVBY A NÁBYTOK



MP KOVANIA s.r.o.

Nová Rožňavská 1 | 831 04 Bratislava
+421 2 444 555 85 | mp@mp-kovania.sk

mp-kovania.sk